

TAD

Operating Instructions

TAD-ST1

Speaker Stand

Thank you for buying this TAD product. This speaker stand should only be used with the TAD-CR1 speaker system. Please read through these operating instructions for proper assembly and use. After you have finished reading the instructions, put them away in a safe place for future reference.

Before You Start

Before setting up your speaker system, we recommend reading the operating instructions for your system thoroughly.

CAUTION

- Do not use this speaker stand with speakers other than the TAD-CR1, since the product balance may be impaired, resulting in tipping or dangerous falls.
- Only use the screws supplied when fixing the speaker to the speaker stand.
- Do not place the stand on an unstable and/or sloping surface. The stand and speaker may fall and cause injury.
- Do not use with any speaker system other than the one for which the unit was designed. The stand may collapse and be damaged and/or the speaker may fall and cause injury.
- When moving the speaker and stand, first remove the speaker from the stand, and then move the stand, holding it by the stems.
- Place the stand on a stable, level surface; placing the stand on an unstable surface can be dangerous.

WARNING

- Technical Audio Devices, Inc. assumes no liability whatsoever for damages resulting from assembly, improper mounting, insufficient reinforcement, misuse of the product, acts of nature, etc.

Parts Included

Check that the following items are located in the accessory case:

- Cone-shaped spikes x 3



- Auxiliary feet x 2



- Hexagon socket bolt x 1



- Hexagon wrench x 1



- Operating Instructions (this document)



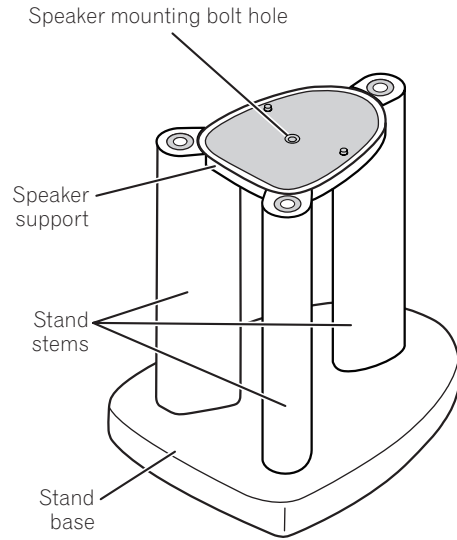

Names of Parts

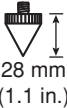
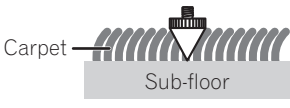

This unit utilizes birch plywood in its construction. As a result, the plies of the plywood may be visible in the appearance.

Select Desired Spikes

Depending on the desired mounting height and condition of the surface on which this speaker unit is to be installed, the spike feet used with this unit can be selected from those provided with the unit, or those provided with the TAD-CR1. Consult the accompanying chart when selecting the spike feet you wish to use.

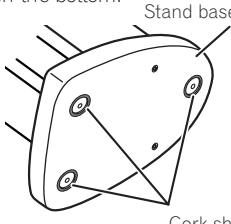
	Spikes	Installation location	Application
Provided with this unit	Cone-shaped spikes (a)  28 mm (1.1 in.)	Locations with thick carpet, floors where no marks will be caused or scars do not matter.	Press spikes into carpet. 
Provided with TAD-CR1	Cone-shaped spikes (b)  19 mm (0.7 in.)	Flat surface	In order to prevent marks on the floor, use the spike bases provided with the TAD-CR1. 
	Round spikes 	Floors with carpets and other uneven surfaces where use of the cone-shaped spikes (with spike bases) would not provide sufficiently stable support.	Can be used as-is.
Use no spikes		Flat surface	The unit can be used as-is since non-skid cork pads have been applied to three positions on the bottom. 

Installing The Spikes

- Spike bases are provided with the TAD-CR1.
- When attaching the three spike feet to the unit, always use the same kind of feet.

1. Screw the spikes in the three locations on the bottom of the stand.

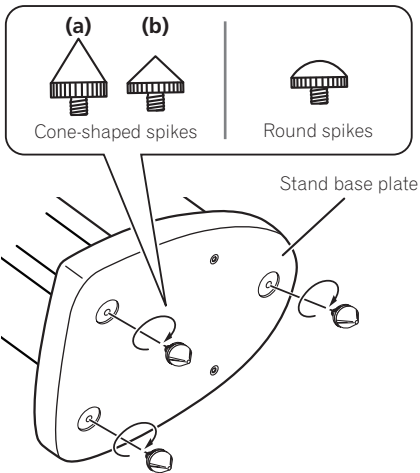

2. Make the necessary preparation in accordance with the type of spikes installed, and install the speaker stand.

- **When using cone-shaped spikes (a)**
Install the stabilizing auxiliary feet in two locations as shown.

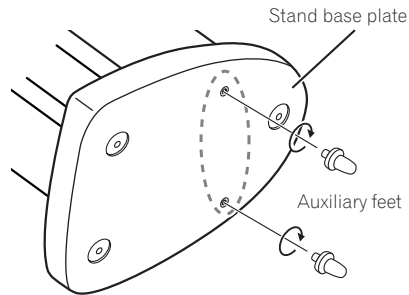

- Install these only when using the cone-shaped spikes furnished with this unit.
- Do not install when using other types of spike feet.

● **When using cone-shaped spikes (b)**

Place the spike bases in the location where the spikes are to rest, then place the speaker stand on top of the spike bases.

CAUTION

- When installing spikes, lay the speaker stands on their sides on a soft blanket or surface to prevent marking.
- Set the spike bases with the concave side upward to receive the spike as shown below.

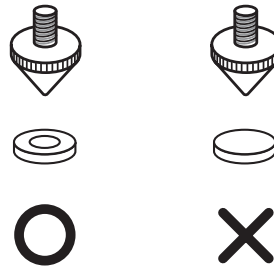

- When the spikes are used alone without spike bases, scratches may be caused to the floor or other installation surface. Always use the spike bases when using spikes.

Attach The Speaker TAD-CR1 to The Stand.

- Use the accessory hexagon wrench when attaching the speakers.
- Mounting bolt hole is located on the bottom of the TAD-CR1.

1. Set the TAD-CR1 on the speaker support plate.

Align the two depressions on the bottom of the TAD-CR1 with the two registration pins on the speaker support plate.

- Be careful not to pinch your fingers.

2. Use the accessory hexagon wrench to tighten the socket bolts.

Use the hexagon wrench to tighten the hexagon socket bolts securely until the spring washer is fully flattened.

- Be careful not to overtighten the bolts, since damage to the unit could result.

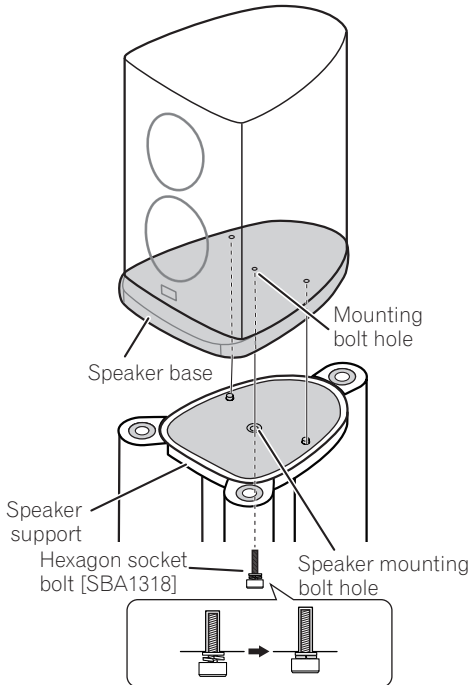

⚠ CAUTION

- Do not use spikes on the bottom of the TAD-CR1 speaker when mounting the speaker on the TAD-ST1 stand, since the speaker will be destabilized and may fall, causing damage or injury.

Specifications

External dimensions

.....407 (W) mm x 532 (H) mm x 525 (D) mm
(16.0 (W) in. x 20.9 (H) in. x 20.7 (D) in.)

Weight 16 kg (35.3 lb)

Supplied accessories

Cone-shaped spikes	3
Auxiliary feet.....	2
Hexagon socket bolt.....	1
Hexagon wrench.....	1
Operating Instructions (this document)	

🔧 Note

Specifications and design subject to possible modification without notice, due to improvements.

Stand maintenance

- Use a polishing cloth or dry cloth to wipe off dust and dirt.
- If the stand is very dirty, use a soft cloth dipped in some neutral cleanser diluted five or six times with water. Finally, wipe again using a dry cloth. Do not use furniture wax or cleaners.
- Never use thinners, benzene, insecticide sprays and other chemicals on or near the stand, since these will corrode the surfaces.

Service Parts List

The following list provides parts numbers for serviceable parts.

Application	Part Name	Part Number
Accessories	Accessory case	SHF1097
	Protector bottom (for accessories)	SHB1215
	Protector top (for accessories)	SHB1214
	Spike	SBA1315
	Auxiliary feet	SBA1306
	Hexagon socket bolt (for speaker mounting)	SBA1318
	Hexagon wrench	SEX1029
	Owner's manual	SRB1343
	Poly bag	SHL6038
	Protection sheet	SHC1884
Packing materials	Spacer	SHC1885
	Packing case	SHH1325
	Protector bottom (for main unit)	SHB1213
	Protector top (for main unit)	SHB1212
For Main Unit	Screw (for speaker support positioning)	SBA1317
	Washer (for SBA1317)	SBE1947
	Screw cap (for SBA1317)	SNK2943
	Base bracket (for attaching spikes)	SNA1524
	Screw (for SNA1524)	BYC35P120FTC
	Damper (for BYC35P120FTC)	SER1376
	Packing (for attaching stand base fixture)	SEC2288
	Non-skid pad (for top surface of stand stems)	SEC2284
	Non-skid pad (Stand base plate)	SEC2285
	Damper (front surface of speaker support)	SER1374
	Damper A (rear surface of speaker support)	SER1375
	Damper B (rear surface of speaker support)	SER1377
	Damper C (rear surface of speaker support)	SER1378
	Damper D (rear surface of speaker support)	SER1379
	Damper (Stand base plate)	SER1381

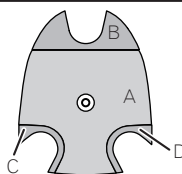



If you want to dispose this product, do not mix it with general household waste. There is a separate collection system for used electronic products in accordance with legislation that requires proper treatment, recovery and recycling.

Private households in the member states of the EU, in Switzerland and Norway may return their used electronic products free of charge to designated collection facilities or to a retailer (if you purchase a similar new one).

For countries not mentioned above, please contact your local authorities for the correct method of disposal.

By doing so you will ensure that your disposed product undergoes the necessary treatment, recovery and recycling and thus prevent potential negative effects on the environment and human health.

K058b_A1_En



TAD

TECHNICAL AUDIO DEVICES LABORATORIES, INC.

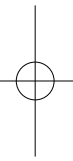
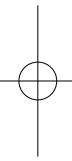

Published by Pioneer Corporation.
Copyright © 2009 TECHNICAL AUDIO DEVICES LABORATORIES, INC.
All rights reserved.

TECHNICAL AUDIO DEVICES LABORATORIES, INC.

4-15-3 Nishi-Shinjuku Shinjuku-ku, Tokyo 160-0023, Japan
<http://tad-labs.com>

<SRB1343-C>

Printed in China